

**DELARAY STAGE 17 BUILDING ENVELOPE PLAN
INCLUDING HEIGHT AND SETBACK PROFILE IDENTIFIER CODE**

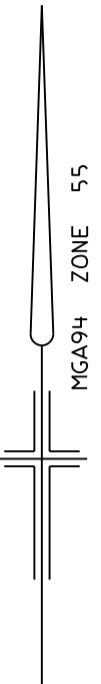
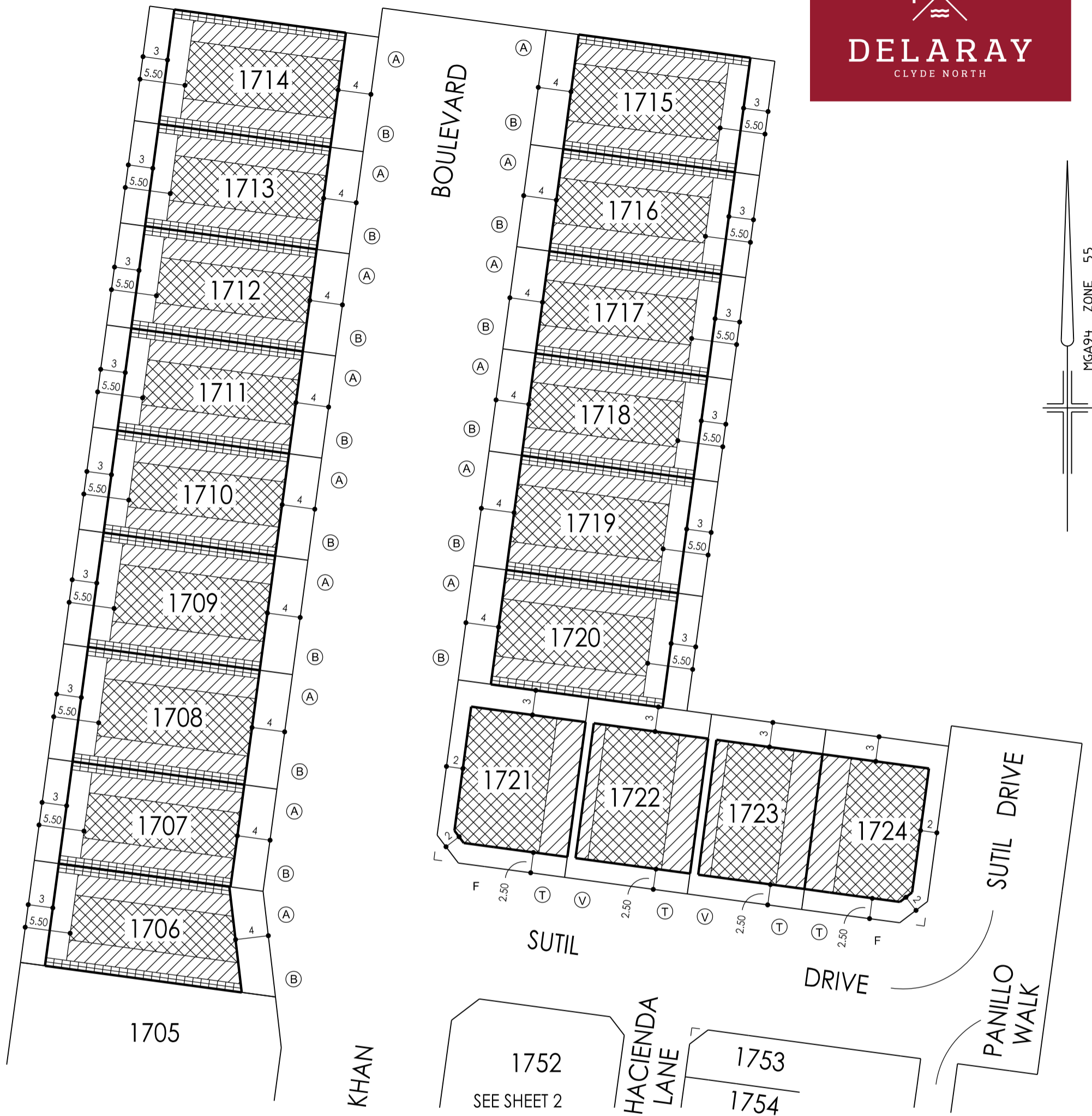

NOTATIONS

'F' DENOTES PRIMARY STREET FRONTAGE OF CORNER LOTS

* LOTS UNDER 250m² DO NOT INCLUDE BUILDING ENVELOPES AS THEY ARE SUBJECT TO EITHER THE SMALL LOT HOUSING CODE OR REQUIRE A SPECIFIC SEPARATE PERMIT FOR A DWELLING. SEE SMALL LOT HOUSING CODE IN RELATION TO TYPE A AND B LOTS

THIS PLAN FORMS PART OF THE "DELARAY BUILDING DESIGN GUIDELINES." PLEASE REFER TO THESE GUIDELINES FOR FURTHER INFORMATION

THE BUILDING ENVELOPES ON THIS PLAN ARE SHOWN ENCLOSED BY CONTINUOUS THICK LINES

PROFILE TYPES (A) (B) (C) (S) (T) (V) ARE CONTAINED IN THE DELARAY BUILDING DESIGN GUIDELINES

ON LOTS WHERE MORE THAN ONE BUILDING TO BOUNDARY ZONE (CROSS HATCHED ON THIS PLAN) IS SHOWN A BUILDING CONSTRUCTED ON THE SAID LOT MUST ONLY BE CONSTRUCTED WITHIN ONE OF THE BUILDING TO BOUNDARY ZONES. (I.E. BUILDING MAY NOT BE CONSTRUCTED FROM BOUNDARY TO BOUNDARY)

SCALE 1:500 AT A3

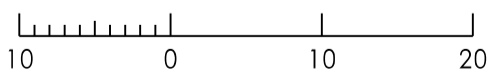

LENGTHS ARE IN METRES

SHEET 1 OF 2 SHEETS
8974/17 VERSION C

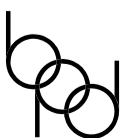

Breese Pitt Dixon Pty Ltd
1/19 Cato Street
Hawthorn East Vic 3123
Ph: 8823 2300 Fax: 8823 2310
www.bpd.com.au info@bpd.com.au

**DELARAY STAGE 17 BUILDING ENVELOPE PLAN
INCLUDING HEIGHT AND SETBACK PROFILE IDENTIFIER CODE**



SEE SHEET 1

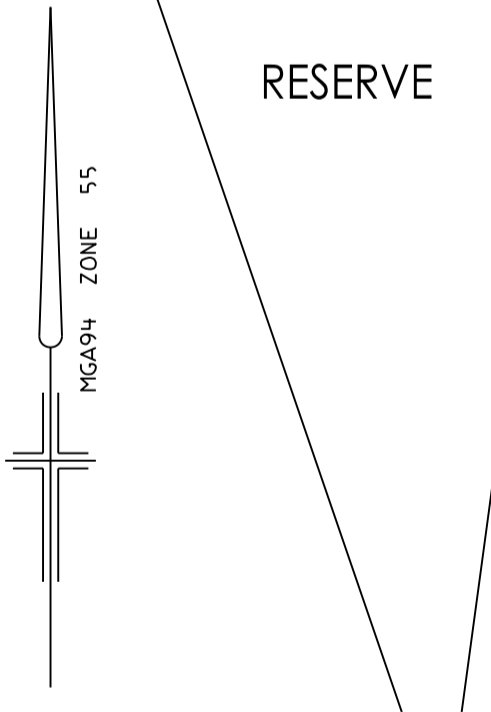
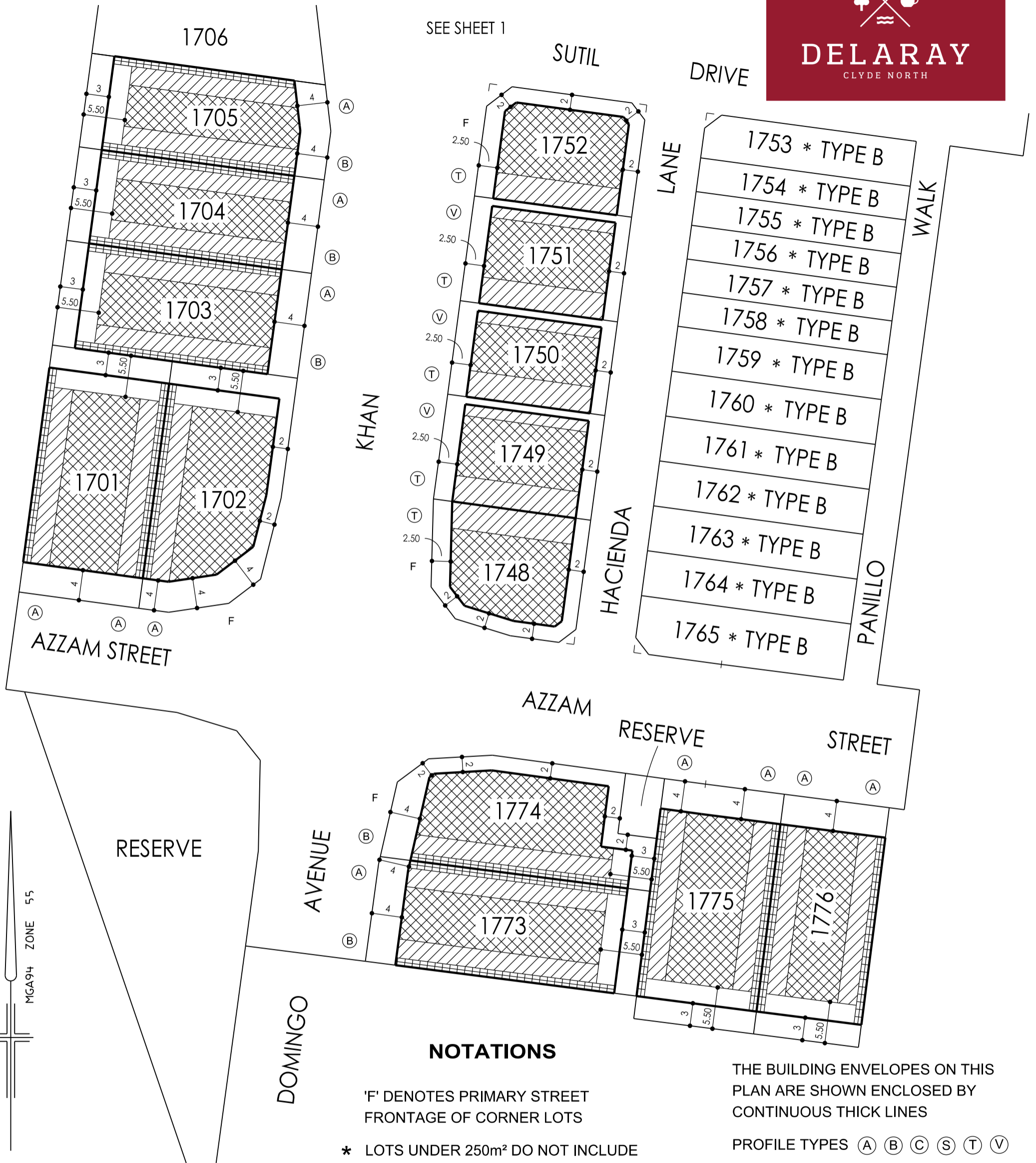

SCALE 1:500 AT A3

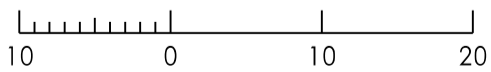

LENGTHS ARE IN METRES

SHEET 2 OF 2 SHEETS
8974/17 VERSION C



Breese Pitt Dixon Pty Ltd
1/19 Cato Street
Hawthorn East Vic 3123
Ph: 8823 2300 Fax: 8823 2310
www.bpd.com.au info@bpd.com.au

NOTATIONS

'F' DENOTES PRIMARY STREET FRONTAGE OF CORNER LOTS

* LOTS UNDER 250m² DO NOT INCLUDE BUILDING ENVELOPES AS THEY ARE SUBJECT TO EITHER THE SMALL LOT HOUSING CODE OR REQUIRE A SPECIFIC SEPARATE PERMIT FOR A DWELLING. SEE SMALL LOT HOUSING CODE IN RELATION TO TYPE A AND B LOTS

THIS PLAN FORMS PART OF THE "DELARAY BUILDING DESIGN GUIDELINES." PLEASE REFER TO THESE GUIDELINES FOR FURTHER INFORMATION

THE BUILDING ENVELOPES ON THIS PLAN ARE SHOWN ENCLOSED BY CONTINUOUS THICK LINES

PROFILE TYPES (A) (B) (C) (S) (T) (V) ARE CONTAINED IN THE DELARAY BUILDING DESIGN GUIDELINES

ON LOTS WHERE MORE THAN ONE BUILDING TO BOUNDARY ZONE (CROSS HATCHED ON THIS PLAN) IS SHOWN A BUILDING CONSTRUCTED ON THE SAID LOT MUST ONLY BE CONSTRUCTED WITHIN ONE OF THE BUILDING TO BOUNDARY ZONES. (I.E. BUILDING MAY NOT BE CONSTRUCTED FROM BOUNDARY TO BOUNDARY)