

DESIGN GUIDELINES

FOR



7 October 2014

INDEX

1. INTRODUCTION

- 1.1 Purpose
- 1.2 The Value of Design
- 1.3 Operation
- 1.4 Construction of Your Home

2. APPROVAL PROCESS

3. SITING & ORIENTATION

- 3.1 Considerations
- 3.2 Land Use
- 3.3 House Orientation
- 3.4 Building Envelopes, Setbacks from Front, Side and Rear Boundaries
- 3.5 Building Height
- 3.6 Site Coverage

4. BUILT FORM

- 4.1 Architectural Style
- 4.2 Materials and Colours
- 4.3 Dwelling Size
- 4.4 Energy Efficiency
- 4.5 Roofs
- 4.6 Garages
- 4.7 Two-Storey Houses
- 4.8 Overshadowing
- 4.9 Privacy and Overlooking

5. EXTERNAL CONSIDERATIONS

- 5.1 Access and Driveways
- 5.2 Fences
- 5.3 Water Saving Initiatives
- 5.4 Broadband Network
- 5.5 Letterboxes
- 5.6 General
- 5.7 Landscaping and Tree Protection

6. NOTES AND DEFINITIONS

- 6.1 Notes on Restrictions
- 6.2 General Definitions
- 6.3 Additional Definitions

7. BUILDING ENVELOPES

8. PROFILE DIAGRAMS

9. CHECK LIST

1. INTRODUCTION

MARRIOTT WATERS is a unique residential community carefully planned to complement the natural environment.

1.1 PURPOSE

The principal aim of these Design Guidelines (“Guidelines”) is to create a coherent vision for the MARRIOTT WATERS community.

Developed to enhance the lifestyle and investment of purchasers, the Guidelines are designed to ensure all homes at Marriott Waters are built to a high standard whilst encouraging a variety of housing styles and compatibility with the streetscape.

The Guidelines will assist in providing you with peace of mind that your investment will be enhanced in the future, guarding against inappropriate development that may detract from the attractiveness of the estate.

1.2 THE VALUE OF DESIGN

Each individual house design should contribute to the surrounding environment and to the estate in a positive way.

Owners are encouraged to construct innovative and appropriate designs that address sustainability issues and present a cohesive residential image for the estate.

Building Envelopes have been designed for allotments to ensure homes are appropriately sited with generous

setbacks and height controls to prevent overlooking and overshadowing.

1.3 OPERATION

The Design Assessment Panel (“DAP”) will comprise an Architect and a representative of the developer. The makeup of the panel may be varied, however the panel will always include at least one Architect member.

All proposed building works including houses, garages, outbuildings and fencing shall be approved by the DAP in relation to these Guidelines prior to seeking a Building Permit.

In considering designs, the DAP may exercise a discretion to waive or relax a requirement.

The Guidelines are subject to change at any time without notice. All decisions regarding these Guidelines are at the discretion of the DAP.

1.4 CONSTRUCTION OF YOUR HOME

Construction of all dwellings must commence within 18 months of settlement.

Incomplete building works must not be left for more than 3 months without work being carried out and all building works must be completed within twelve months of their commencement.

2. APPROVAL PROCESS

The following steps illustrate the process for each purchaser in order to construct a house at Marriott Waters.

Step 1 - Awareness

Homes must be designed in accordance with the Guidelines. Preliminary advice may be sought from the DAP at the time of purchase to ensure that concept designs will meet the requirements of the Guidelines.

Step 2 - Submission

Designs are to be submitted in **duplicate** to DAP for approval as follows:

- House floor plans (1:100 scale)
- Elevations from four sides (1:100 scale)
- Roof plan
- Site plan (1:200 scale) showing:
 - setbacks from all boundaries
 - Building Envelope
 - existing contours
 - proposed finished floor levels and site levels
 - external features including driveways, paths, fencing and outbuildings
 - Landscaping
- Schedule of external materials and colours
- Energy First Rate Report
- Completed Check List (refer Section 9 of Guidelines)

Submit all information to:

**MARRIOTT WATERS DESIGN
ASSESSMENT PANEL**
PO Box 356
Mont Albert Vic. 3127
dap@kosaarchitects.com.au

Step 3 - Approval

The DAP will promptly approve plans that comply with the Guidelines. If all documents have been submitted and meet compliance, allow approximately 10 working days for approval.

Step 4 – Re-submission

Plans that do not comply with the Guidelines will be returned with the areas of non-compliance highlighted. Amended plans can be resubmitted for approval.

Any alterations made to the resubmission other than the initial non-compliance should also be highlighted on the plans or on accompanying letter.

Step 5 – Building Permit

After approval from the DAP, you must then obtain a Building Permit from the City of Casey or a Private Building Surveyor.

Note: Design approval from DAP does not exempt the plans from any building or statutory regulations. Separate approval must be obtained from the relevant authorities. Approval by the DAP does not infer compliance under the Building Code of Australia, Rescode and other applicable planning or building regulations.

Step 6 – Construction

Once a Building Permit has been obtained, construction of your house may begin.

3. SITING & ORIENTATION

3.1 CONSIDERATIONS

Careful siting of houses and garages is important for a number of reasons:

- Ensuring best visual presentation from the street;
- Maximising the benefits of solar access;
- Promoting energy efficiency;
- Minimising overlooking; and
- Respecting the privacy and amenity of neighbours.

3.2 LAND USE

One dwelling only is permitted per allotment. Dual occupancy and further subdivision is not allowed. This excludes those lots designated for medium density housing.

3.3 HOUSE ORIENTATION

Houses must face the main street frontage and present an identifiable entrance to the street. Where possible, houses should be sited so that habitable rooms and private open spaces face northwards to receive maximum solar efficiency.

3.4 BUILDING ENVELOPES, SETBACKS FROM FRONT, SIDE AND REAR BOUNDARIES

Building Envelopes

Building Envelopes have been prepared for the lots in each stage at Marriott Waters and are contained within the Guidelines. The construction of houses or associated buildings, including garages, must be contained within the Building Envelope specified for that allotment in the Guidelines (if a Building Envelope is provided) and in accordance with the Profile Diagrams depicted in the Guidelines.

Building Envelopes are not provided for lots less than 300 square metres, these lots will require a Planning Permit.

Setbacks

The following setbacks for houses and garages must be met.

(i) The Front Street

The front street setback is designated on the specified Building Envelope for each allotment. All houses must be set back from the main street frontage by the minimum distance indicated.

Garages must be sited within the Building Envelopes and garage entrances must be a minimum of 5 metres from the front street boundary unless otherwise noted in the Creation of Restriction on the Plan of Subdivision or approved by the DAP.

(ii) Splayed and curved street frontages

Unless noted on the plan, the minimum front setback on a splayed or curved corner between two street frontages is on an arc connecting the front street setback line to the side street setback line commencing at the points that are perpendicular to the points where the street alignment commences to arc. Front entrances are to be easily accessible from the main street frontage.

(iii) The Side Boundaries

The side setback is designated on the specified Building Envelope for each allotment.

Walls may be built to the side boundary if provided for on the Building Envelope (see also 'Walls on boundaries' below). The measurements are taken from the natural surface levels to the top of the wall.

A building must be setback from a side boundary not less than the

distances specified in the Profile Diagrams and shown on the Building Envelopes by a setback identifier code.

Garages may be built to the side boundary if provided for on the Building Envelope and adjacent buildings allow.

The measurements are taken from the natural surface levels to the top of the wall.

(iv) The Side Street Boundary

The side street setback is designated on the specified Building Envelope for each allotment.

(v) The Rear Boundary

The maximum height of a building facing a rear boundary must not exceed the maximum building height allowed by the side envelope profile as shown in the Profile Diagrams, or a height limit for a rear setback as dimensioned on the Building Envelope plan.

(vi) Walls on boundaries

Walls and associated parts of a building to an "S" or "T" profile boundary are permitted to be on the boundary or 1.0 metre from the boundary. On the boundary means 0 -200 mm from the title boundary.

Building to boundary zones (BBZ)
Garage walls and outbuildings within 1.2 metres of a boundary are restricted to areas within a Building to Boundary Zone (BBZ). The BBZ spans the length of the side boundary between the front and rear setbacks permitted by this Building Envelope. Within the BBZ, the following apply:

- Only garages and outbuildings are permitted within a BBZ

unless otherwise noted within the Building Envelope.

- Carports and verandahs are not permitted to be built to the boundary.
- Maximum height of a wall in the BBZ is restricted to 3.6 metres
- For terrace allotments, building height within the BBZ must not exceed the height as specified in the Profile Diagrams.
- Walls less than 1.2 metres from the boundary must be within 200 mm of the boundary.

(vii) Encroachments

Side, Side Street and Rear: The following may encroach into the specified setback distances by not more than 600mm:

- Porches and verandahs
- Masonry chimneys
- Screens, but only to the extent needed to protect a neighbouring property from a direct view
- Water tanks
- Heating and cooling equipment and other services

The following may encroach into the specified setback distances:

- Landings with an area of not more than 2 square metres and less than 0.8 metres high
- Unroofed stairways and ramps
- Pergolas
- Shade sails
- Eaves, fascia, gutters

Front: The following may encroach into the specified front street setback distances by no more than 1000mm:

- Porches, verandahs and porticos.
- Decks and uncovered landings of not more than 2 square metres and less than 0.8 metres high from natural ground

- Eaves and architectural features.
- Gutters are exempt from calculations.

(viii) Edge Boundary

Exemptions relating to side setbacks and relating to siting matters do not apply to an Edge Boundary.

3.5 BUILDING HEIGHT

The maximum building height is 10.0 metres above the natural surface level of the ground directly below it.

A maximum rise of 2 storeys is permitted.

For the purpose of the Guidelines, a maximum wall height of 7.2 metres is permitted above natural ground level.

Natural ground/surface level is defined as the ground level after engineering works associated with the subdivision have been completed. Sloping sites which may allow additional built area under the ground floor level will be considered and may be approved depending upon overall design and setback requirements. Large bulk excavations or high retaining walls are not permitted.

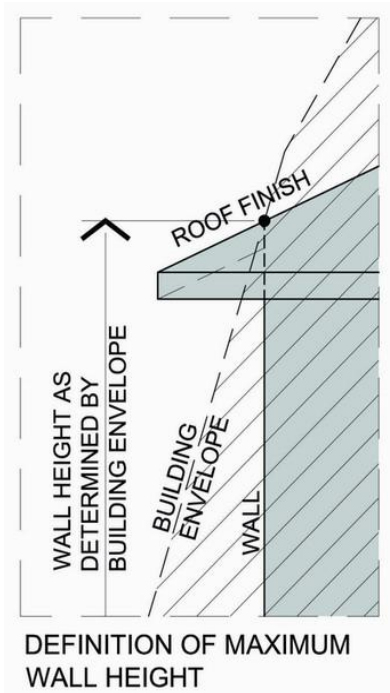

3.6 SITE COVERAGE

Buildings must not occupy more than 60% (for S and T profiles 70%) of the lot, regardless of the extent of building area outlined in the Building Envelope and Profile Diagrams.

In calculating site coverage, eaves, fascia and gutters not exceeding 600mm in total width, and unroofed swimming pools, terraces, patios, decks and pergolas may be disregarded. Roofed areas of terraces, patios, decks and pergolas are to be included in overall calculations.

4. BUILT FORM

4.1 ARCHITECTURAL STYLE

At Marriott Waters, high standards of house design will be required and a variety of styles are encouraged. Designs should be responsive to the individual attributes of the lot, having regard to any slope or vegetation.

Designs that break the front of the dwelling into distinct visual elements will be supported. The inclusion of projections integral to the design and style of the dwellings such as verandahs are encouraged. Further enhancement can be achieved through the use of detail and shade in the form of pergolas and extended eaves.

Houses with identical facades may not be constructed in close proximity and identical houses must be separated by a minimum of four houses in any direction.

The appearance of dwellings should provide a degree of richness and variety ensuring the creation of pleasant, interesting streetscapes.

Houses which have long uninterrupted expanses of wall should be avoided. Features, which may detract from the appearance of a house from the street, including small windows, obscure glass, window security shields, canvas and metal awnings, will be discouraged.

4.2 MATERIALS AND COLOURS

The materials and colours of the walls and roofs of houses will have a major impact on the visual quality of MARRIOTT WATERS. The use of a combination of finishes is encouraged for the purpose of achieving a degree of individuality and interest.

Thoughtful selection of materials and colours will achieve a degree of visual harmony between houses and will avoid

colours that are out of character with neighbouring houses.

For these reasons, purchasers are requested to submit roof and wall materials and colours for approval.

External Walls

- The external walls (excluding windows) are to be constructed of brick, brick veneer, texture coated material, weatherboard or other material as approved by the DAP. Colours of trims should be selected to complement the main body of the house.

Roofs

- The roof is to be constructed of steel, masonry or terracotta roof tiles or as approved by the DAP. Terracotta, grey, green and red (in muted tones) are recommended as roof colours as these colours reflect the natural tones of the environment at MARRIOTT WATERS.

4.3 DWELLING SIZE

The minimum dwelling size is:

- 160 square metres (approx. 17 squares) excluding garage for allotments with an area of 500 square metres or greater.
- 130 square metres (approx. 14 squares) excluding garage for allotments with an area of less than 500 square metres.
- 85 square metres (approx. 9 squares) excluding garage for terrace lots.

4.4 ENERGY EFFICIENCY

An energy smart home takes advantage of the sun's free warmth and light and, with the inclusion of energy efficient appliances and systems, will save a great deal of energy.

Well designed homes reduce the demand on heating and cooling. Any style of house can be energy efficient. Energy smart homes have a combination of features which work together to ensure you achieve the highest degree of comfort with minimum energy use. Where split system air conditioners are installed, systems must have a minimum 5 star heating and cooling rating.

Homes at MARRIOTT WATERS must achieve the minimum standard energy rating as required by the current Building Regulations. A copy of the Energy First Rate Report, prepared in accordance with the Victoria Home Energy Rating System, is to be submitted to the DAP at the time of application to confirm compliance.

4.5 ROOFS

Articulated roof shapes are preferred, with hips and gable roof forms encouraged, although each design will be considered on its merits by the DAP.

4.6 GARAGES

The garage and family car(s) have a significant impact on the streetscape. The design and location of garages should endeavour to make them an integral and unobtrusive part of the house.

All homes must allow for garage car accommodation. Garages must be constructed within the Building Envelope and sited a minimum of 5.0 metres from the front street boundary. For lots with an area of between 300sqm and 500sqm, the garage must be setback a minimum of 5.5m from the front

street boundary unless otherwise noted in the Creation of Restriction on the Plan of Subdivision or approved by the DAP.

The garage setbacks also apply for entry to the garage from the side street boundary.

It is preferable for garages to be constructed under the main roof of the house. If garages are free standing and/or visible from the street, they should match the roof form and be constructed of the same materials as the house.

The garage may be constructed to the side boundary, depending on the location of adjacent buildings and garages relative to the side boundaries and whether permitted in the Building Envelope. Deep excavations on the boundary will not be permitted - this would cause detriment to adjoining properties.

Secondary garages are discouraged. The design for an additional garage would need to be discussed with the DAP and it must be disguised and out of view from the main street frontage. Only one crossover is permitted and only one double garage door is permitted to be visible from the main frontage of the house.

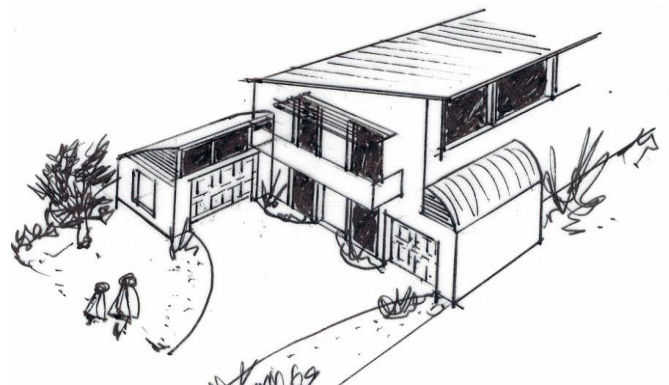

When designing garages, consideration must be given to the screening of boats, caravans and trailers and for 'drive-through' access to the rear yard.

No carports shall be visible from the street frontage.

The garage door is considered a major visual element of the streetscape. Doors must be complimentary to the house style and colour and reflect a contemporary style.

Sectional overhead and panelled tilt type doors are preferred and the inclusion of windows, recesses or projections in the garage door should be considered so as to present an interesting and integrated façade.

Roller doors may be used at the discretion of the DAP depending on the colour, location and style of the door.

4.7 TWO-STOREY HOUSES

It is important to ensure that two-storey houses are designed and sited correctly to minimise overlooking and overshadowing. It is recommended that initial concepts for two-storey houses be discussed with the DAP.

The stepping-back of the front of the upper level of two-storey houses is encouraged to avoid dominating the streetscape.

4.8 OVERSHADOWING

Daylight to existing habitable room windows

A building must be setback in accordance with both the Building Envelope plan and the Profile diagrams. Building Regulations 416, 417, 418 and 420 are superseded by these Guidelines.

4.9 PRIVACY AND OVERLOOKING

Overlooking from habitable room windows

If a habitable room window is in a part of the building within an overlooking zone, any part of the window that is more than 2.5 metres above natural ground level must not allow a direct view to an adjoining lot. This does not apply to windows in a rear wall, which comply with the specified rear setbacks.

Overlooking from raised open spaces

A raised open space within an overlooking zone and with a floor level of more than 0.8 metres above natural ground level must not allow a direct view to an adjoining lot.

A direct view is:

- (i) **From a habitable room window**, any line of sight measured from a height of 1.7 metres above
 - (a) a vertical plane measured at an angle of 45 degrees from each side of the window, and
 - (b) the floor level of the habitable room, and
 - (c) the ground level below, and
 - (d) a horizontal distance of 9 metres from the window.
- (ii) **From a raised open space**, any line of sight measured from a height of 1.7 metres above the floor level and along the perimeter of the raised open space to any point within a horizontal distance of 9 metres from the raised open space and extending 45 degrees beyond any point where the perimeter of the raised open space meets a wall of the building.

5. EXTERNAL CONSIDERATIONS

5.1 ACCESS AND DRIVEWAYS

Driveways are a major visual element at MARRIOTT WATERS and should be constructed using materials that blend with or complement the dwelling textures and colours.

Only one driveway will be permitted for each lot, unless there are special circumstances which will be considered by the DAP.

Driveways must not be wider than the crossover width at the property boundary of a lot and planting between the driveway and property boundary is encouraged.

Any variations to the crossover widths to be approved by the DAP and the City of Casey prior to construction.

Recommended paving materials include stone, brick or coloured concrete. All driveways should be completed within three months of the Occupancy Permit being issued.

5.2 FENCES

The objective of the DAP is to provide a degree of uniformity throughout the estate and thereby avoid an untidy mix of various fence standards, colours and types.

To enhance the park-like character of the estate, no front fencing will be permitted.

On side boundaries, no fencing is permitted forward of the building line.

All side and rear fences are to be constructed of timber palings with exposed posts and capped across the top to a maximum height of 1.8 metres (excluding a screen required for overlooking purposes).

This restriction for the rear fences does not apply to Lots 230 to 246 (inclusive) and does not apply for the side fence of Lot 301. These allotments abut Reserve No. 3 and will be permitted to have an alternate style of brush fencing to 1.8 metres in height with timber capping across the top, timber rails to the bottom, exposed timber posts with intermittent feature exposed stone columns to 2.1 metres or such other fencing as may be approved in writing by the Design Assessment Panel.

For the purposes of these Guidelines, the prescribed fence height of 1.8 metres to the side street, side and rear boundaries will be exempt from the provisions of the Building Regulations.

Fences permitted by the Guidelines are not deemed to overshadow the recreational private open space on the allotment.

5.3 WATER SAVING INITIATIVES

MARRIOTT WATERS is committed to saving water and encourages the use of recycled water.

It is envisaged that recycled water will be made available to the estate. All homes will be required to install suitable plumbing to provide recycled water to the toilet and for irrigation and external uses. Further uses may be permitted at a later time.

All residents are encouraged to consider other water saving initiatives in the home including:

- Front loading washing machine (AAAA rating or greater).

- Dishwasher (AAAA rating or greater)
- Garden with native plant species (more than 70%), or other appropriate drought tolerant plants.
- Rainwater to infiltrate into the garden as opposed to draining out to the stormwater system.
- Garden irrigation drip system (rather than sprayers).

5.4 BROADBAND NETWORK

Marriott Waters is an OptiComm Fibre Connected Community. This means that all homes in Marriott Waters will have access to the OptiComm high speed broadband network. Some benefits of high speed broadband are:

- Distribution of digital free to air television
- Ultra-high speed Internet - even in high usage times and not affected by distance from an exchange
- Pay TV - choice of providers
- External aerials and satellite dishes are not required

What you need to do to prepare for High Speed Broadband:

Step 1. Conduit (Pipe) Installation

You must make sure your builder has prepared the house in accordance to OptiComm's latest version of the Cable Entry Guide with conduit from the starter pipe to the side of the dwelling as well as conduit within the home to the proposed location for the installation of OptiComm's Network Termination Device (NTD). The specifications of this conduit can be found in OptiComm's reference document Cable Entry Guide. Typical costs for up to 10 metres of trenching and conduit would be \$440 (GST inclusive). The Cable Entry Guide is available on OptiComm's web site www.opticomm.net.au or by phoning the OptiComm Customer Connection Information Desk on 1300 137 800. This conduit should be installed during construction of your home.

Step 2. Prepare your home to be able to distribute the Internet, Telephone, TV and other services throughout your rooms

Structured Cabling of your home is *optional*, but highly recommended, as it will enable you to take advantage of all features the Marriott Waters Optical Fibre Network has to offer. It is recommended that you arrange a quote to cable your new home from your builder or an ACMA registered data cabler early in your construction phase or at contract negotiation as the wiring should be done at the frame stage of construction. Structured Cabling is an additional cost to the conduit and customer connection.

Step 3. Connection to the Optical Fibre Network

When you have received your Certificate of Occupancy or about two (2) weeks before you move in, register your fibre connection by visiting the OptiComm web site <http://www.opticomm.net.au> and follow the "Get Connected" link or call OptiComm's Customer Connection Information Desk on 1300 137 800.

The customer connection cost is \$550.00 incl. GST and includes the following services:

- Installation of Optical Network Terminal and the Power Supply Unit
- Access to Free to Air Digital TV signals
- Access to Foxtel Pay TV signals (resident to arrange for Foxtel connection at their cost)

Step 4. Contact a Retail Internet and Telephone Service Provider

Finally, the last step involves contacting a Retail Service Provider to arrange the connection of your Retail Internet and Telephone Services (see details over page). You will be contracting the Retail Service Provider to provide the Internet and Telephone Services over the OptiComm Wholesale Network.

Hints when discussing your requirements:

- Tell them you are in an OptiComm Fibre Community
- Make sure you tell them you are at Marriott Waters.
- Make sure you give them your full address
- Tell them whether you have moved in yet
- Advise them whether you have had OptiComm install the Optic Fibre and Network Termination Device (known as a Optical Network Terminal (ONT)) - this will affect the time it takes to connect services
- If speaking with Foxtel make sure you tell them you are in an OptiComm Fibre Estate and the "ONT" (Optical Network Terminal) is installed

For further information please refer to:
<http://www.opticomm.net.au/>

Further information on connecting to the fibre optical network will be available from the Marriott Waters website at www.marriottwaters.com.au

5.5 LETTERBOXES

Letterboxes should be designed to complement the appearance of the house and must use similar materials and colours as the house. Temporary letterboxes are not acceptable.

5.6 GENERAL

External fixtures must achieve the following objectives and the location must be noted on plans to be submitted to the DAP:

Clothes-lines, Garden Sheds, External Hot Water Services and Ducted Heating Units must not be visible from the street.

Garden Sheds must be no greater than 10 square metres and no greater in height than 2.4 metres and are

permissible outside the building envelope.

Solar Water Heaters are permitted and, where possible, are to be located out of view from the street frontage. The solar panels shall be located on the roof, not on a separate frame, and the storage tanks detached and concealed from public view, by locating them within the roof space or house.

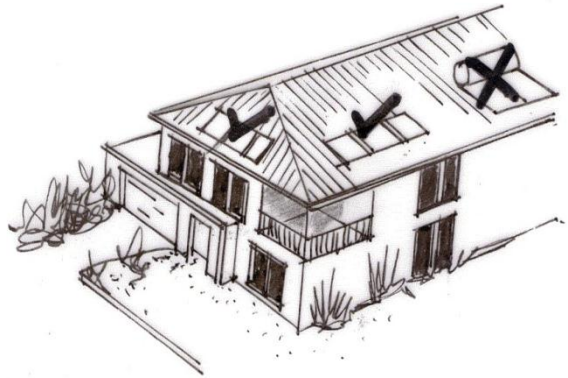

Air-Conditioning Units

Evaporative air-conditioners must be positioned so that they are not visible from the main frontage of the dwelling. They must be painted to match the colour of the roof, be low profile units and installed as low as possible below the roof ridgeline towards the rear of the house.

Wall mounted air-conditioners must be located below the eaves line, screened from public view and suitably baffled to reduce noise.

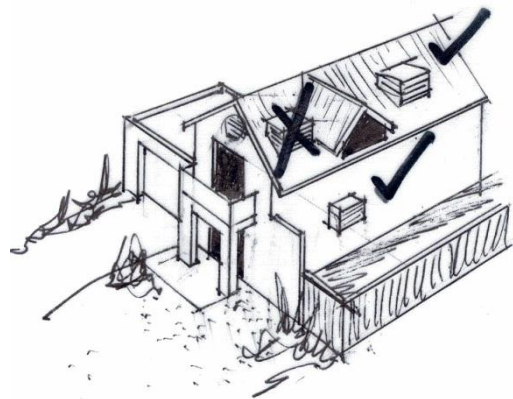

Television Antennae must be located within the roof of the house or below the

roof ridgeline and not visible from public view.

Satellite Dishes will only be approved if located below the roofline of the house and must be screened from public view.

Rainwater Tanks must be not visible from the street frontage.

No external **Plumbing** to a dwelling shall be visible from a street or dwelling. All plumbing on double-storey houses, except downpipes, must be internal so as not to be visible from the street or neighbouring properties.

External lighting including spotlights, flood lights and any lights illuminating any outdoor area are to be approved by the DAP.

Rubbish Bins & Recycling Bins should be stored out of view from the street.

Commercial Vehicles with a carrying capacity of 1 tonne or more or any boat, caravan or trailer shall not be permitted to be parked on a lot so that it is visible from any street.

Advertising Signage

Signage is not permitted on residential lots with the following exceptions:

- Only one advertising sign will be permitted to be erected on a lot that is being advertised for resale.
- Display home signage will be permitted but only with the written approval of the DAP.

Builders or tradespersons identification required during construction of the dwelling to a maximum size of 600mm x 600mm. Such signs must be removed within 10 days of the issue of the Certificate of Occupancy.

Window Furnishings

Internal window furnishings which can be viewed by the public must be fitted within three months of occupancy. Sheets, blankets or similar materials for which window furnishing is not their primary use will not be permitted.

5.7 LANDSCAPING AND TREE PROTECTION

General Guidelines

The garden design will require careful thought to ensure that the appropriate plants are selected for the particular lot conditions.

The objective is to achieve a cohesive blend of indigenous vegetation and other landscape elements, integrating street and parkland landscaping with private gardens so that the streetscape presents as a landscaped garden.

Landscape design and plant selection should minimise the need for garden watering. No tree or shrub with a mature height greater than 3 metres should be planted closer than 2 metres to the house. Purchasers should make their own enquiries with the City of Casey and obtain a list of allowable vegetation.

Front Gardens

All landscaped areas to the front of the house must be established within three months of the issuing of the Occupancy Permit to ensure that a good presentation is achieved for the local community.

Embankments

Embankments should not exceed a slope of 1 in 5. Retaining walls are preferred to steep embankments and should be kept to a maximum height of 900 mm – a number of small terraces are preferred.

6. NOTES AND DEFINITIONS

6.1 NOTES ON RESTRICTIONS

- Ground level after engineering works associated with the subdivision is to be regarded as natural ground level.
- In the case of a conflict between the Building Envelope plan or Profile Diagrams and these written notations, the order of precedence is as follows:
 1. Building Envelope plan
 2. Creation of Restriction on Plan of Subdivision
 3. Design Guidelines
- Buildings and structures must not cover registered easements unless provided for by the easement.

6.2 GENERAL DEFINITIONS

If not defined above, the words below shall have the meaning attributed to them in the document identified:

In the *Building Act 1993*:

- Building
- Lot

In Part 4 of *Building Regulations 2006*:

- Clear to the sky
- Height
- Private open space
- Recreational private open space
- Raised open space
- Setback
- Site coverage
- Window
- Single dwelling
- North (true north)

In the *Victoria Planning Provisions*, 31 October 2002:

- Frontage (Clause 72)
- Dwelling (Clause 74)
- Habitable room (Clause 72)
- Storey (Clause 72)

6.3 ADDITIONAL DEFINITIONS

Edge Boundary

Edge Boundary means the boundary or part of a boundary of a lot on the Plan of Subdivision that abuts a lot, which is not shown on the Plan of Subdivision. An Edge Boundary lot is marked "E" on the Building Envelope plan.

Front street or Main street frontage

Front Street means the street or road that forms the frontage to the lot concerned. Where there is more than one road which adjoins a lot or where it may be otherwise unclear, the Front Street will be identified by the letter "F" in the Building Envelope Plan or will be as agreed in writing by the DAP.

Side boundary

A boundary of a lot that runs between and connects the street frontage of the lot to the rear boundary of the lot.

Street

For the purposes of determining street setbacks, street means any road other than a lane, footway, alley or right of way.

Standard lot

A single lot that accommodates a freestanding house detached from adjoining houses and of an individual style.

Terrace lot

A single lot assigned with an S or T profile boundary.

7. BUILDING ENVELOPES

Refer attached Building Envelopes

To be read in conjunction with Profile Diagrams (refer Section 8) and Marriott Waters Plan of Subdivision for relevant stage.

8. PROFILE DIAGRAMS

Profile Diagrams (7 pages)

To be read in conjunction with Building Envelopes (refer Section 7) and Marriott Waters Plan of Subdivision for relevant stage.

PROFILE DIAGRAMS

Explanation of symbols and terms in profile diagrams and plans

The following symbols have been used in the templates:-

Building Envelope Profile Types

- (A) Building Envelope Profile Type A
- (B) Building Envelope Profile Type B
- (C) Building Envelope Profile Type C
- (D) Building Envelope Profile Type D
- (E) Building Envelope Profile Type E
- (F) Building Envelope Profile Type F
- (G) Building Envelope Profile Type G
- (H) Building Envelope Profile Type H
- (I) Building Envelope Profile Type I
- (J) Building Envelope Profile Type J
- (K) Building Envelope Profile Type K
- (L) Building Envelope Profile Type L
- (R) Building Envelope Profile Type R
- (S) Building Envelope Profile Type S
- (T) Building Envelope Profile Type T
- (V) Building Envelope Profile Type V

Single Storey Building Envelope hatch types



Single Storey Building Envelope (wall height not exceeding 3.6m)

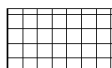

Building to Boundary Zone

Double Storey Building Envelope hatch types



Overlooking Zone - Habitable room windows or raised open spaces are a source of overlooking.



Non Overlooking Zone - Habitable room windows or raised open spaces are not a source of overlooking.

(A) Profile - NORTH, EAST or WEST Boundary

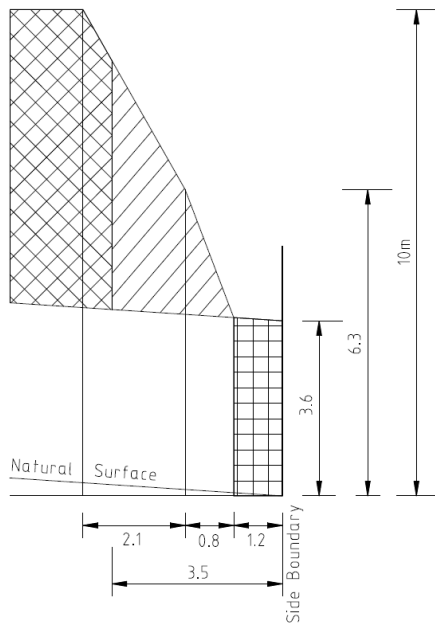

Natural Surface rising from side boundary.

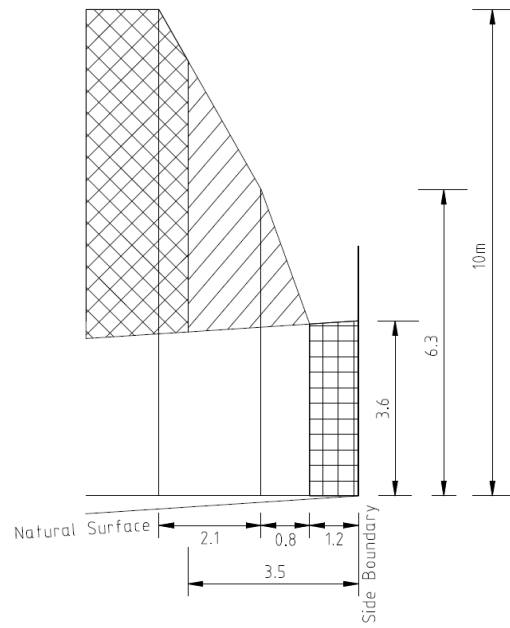

Natural Surface falling from side boundary.

(B) Profile - SOUTH Boundary

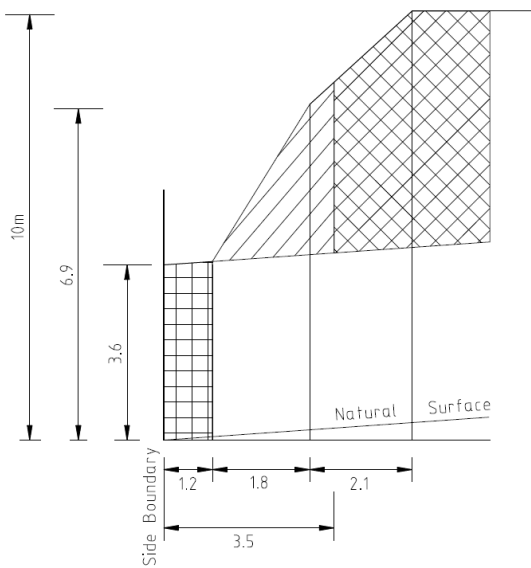

Natural Surface rising from side boundary.

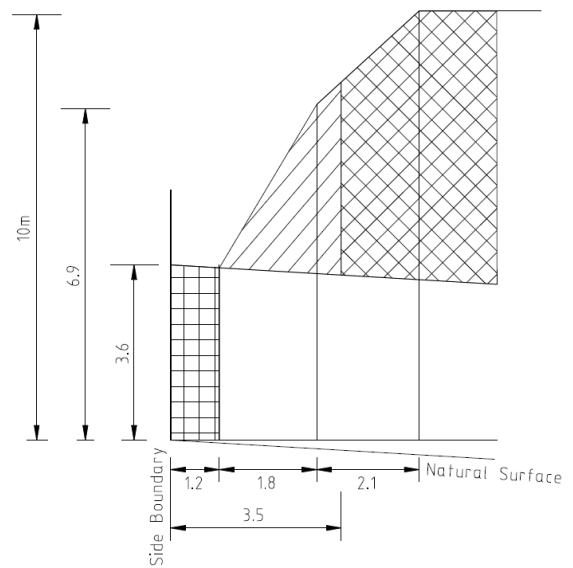

Natural Surface falling from side boundary.

C Profile - NORTH, EAST or WEST Boundary

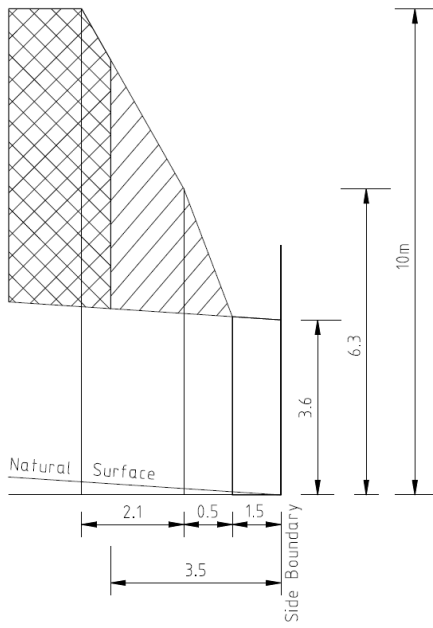

Natural Surface rising from side boundary.

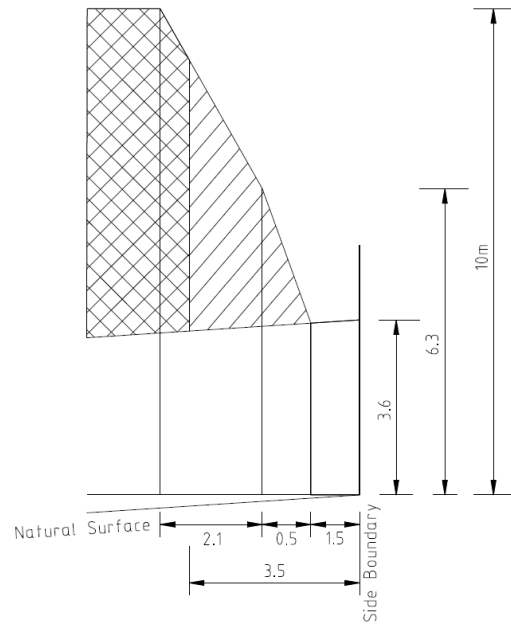

Natural Surface falling from side boundary.

D Profile - SOUTH Boundary

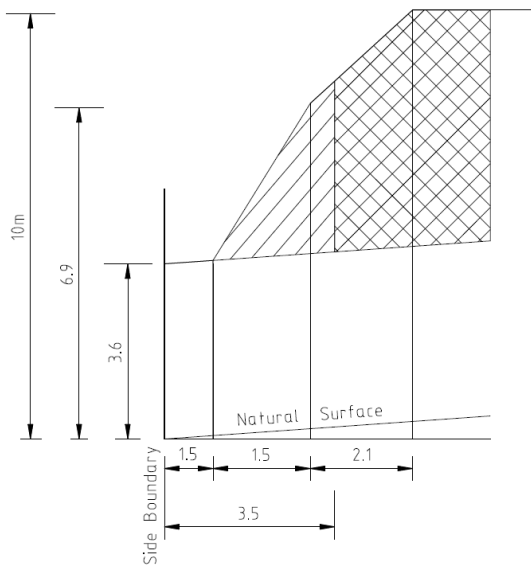

Natural Surface rising from side boundary.

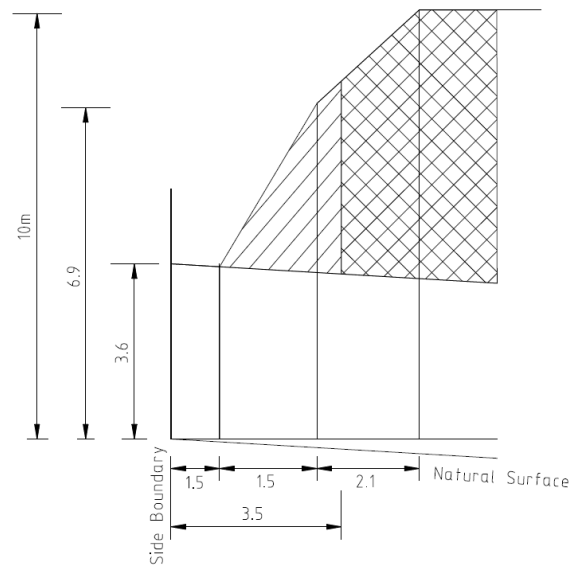

Natural Surface falling from side boundary.

E Profile - NORTH, EAST or WEST Boundary

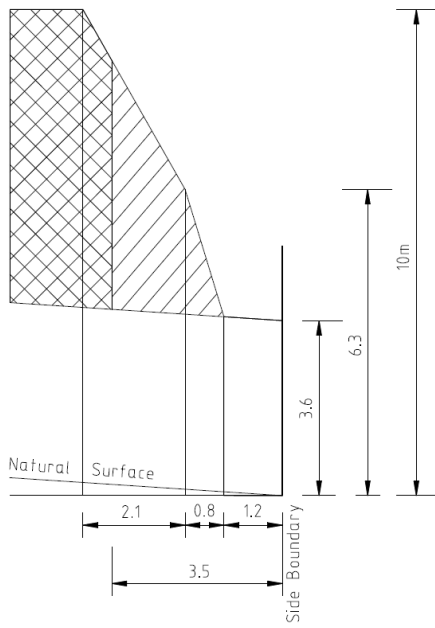

Natural Surface rising from side boundary.

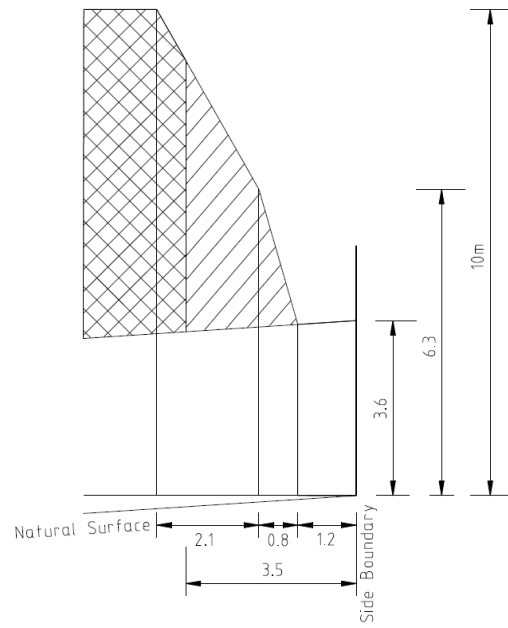

Natural Surface falling from side boundary.

F Profile - SOUTH Boundary

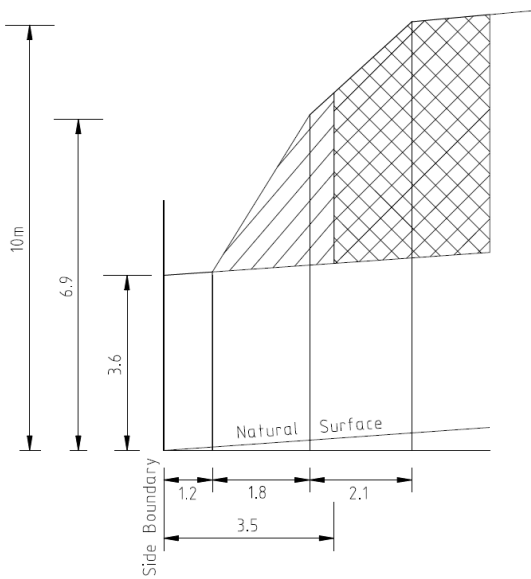

Natural Surface rising from side boundary.

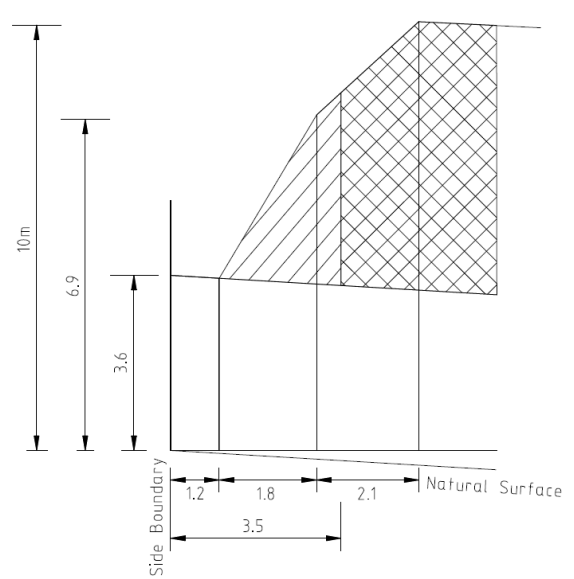

Natural Surface falling from side boundary.

G Profile - NORTH, EAST or WEST Boundary

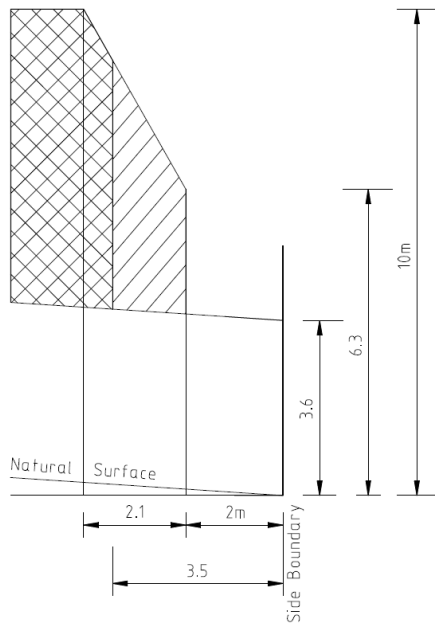

Natural Surface rising from side boundary.

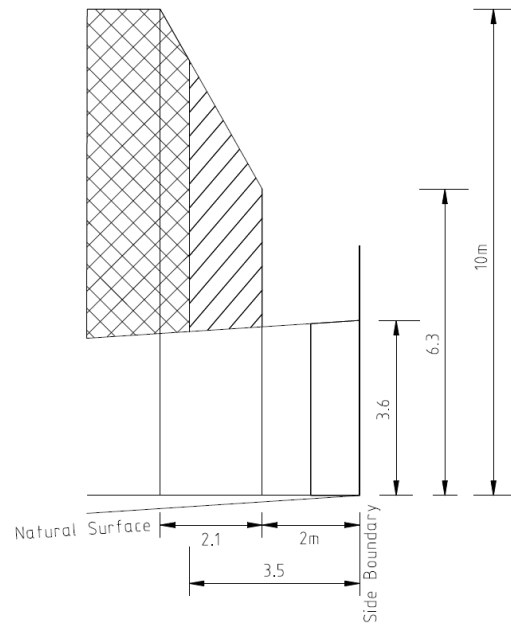

Natural Surface falling from side boundary.

H Profile - SOUTH Boundary

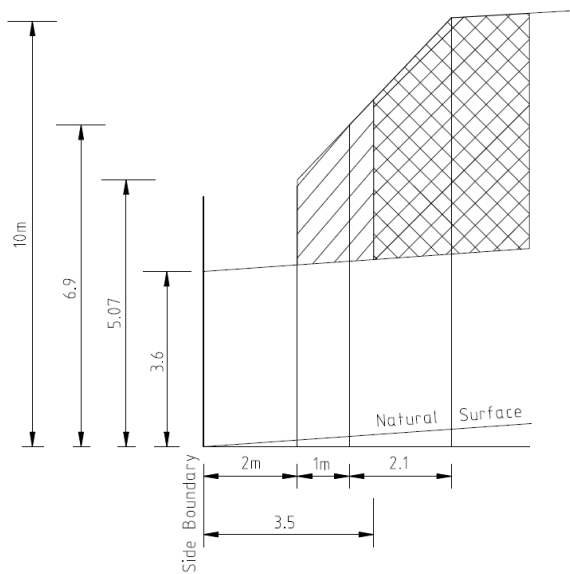

Natural Surface rising from side boundary.

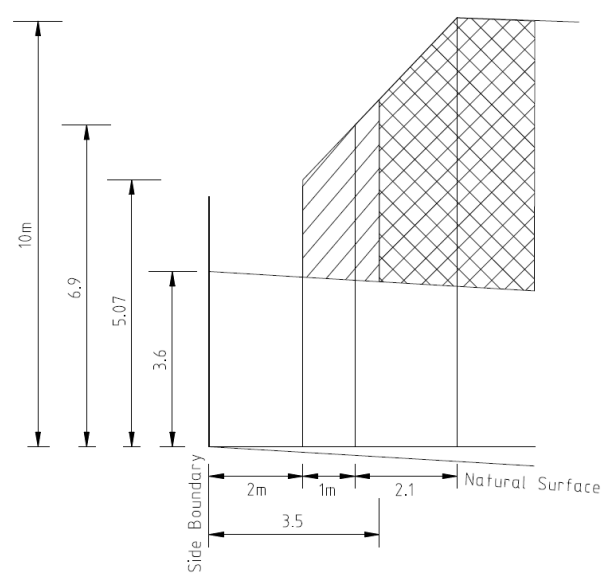

Natural Surface falling from side boundary.

Profile - NORTH, EAST or WEST Boundary

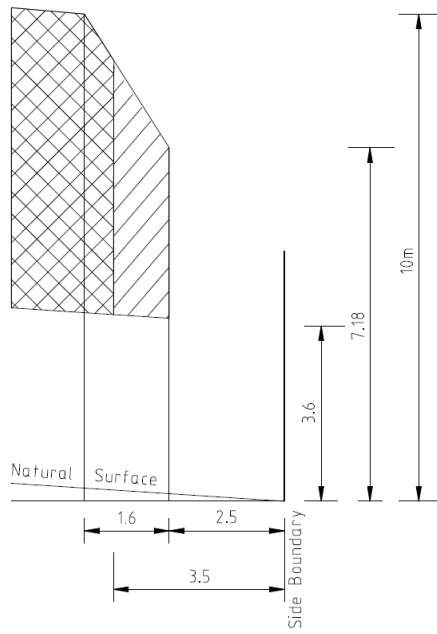

Natural Surface rising from side boundary.

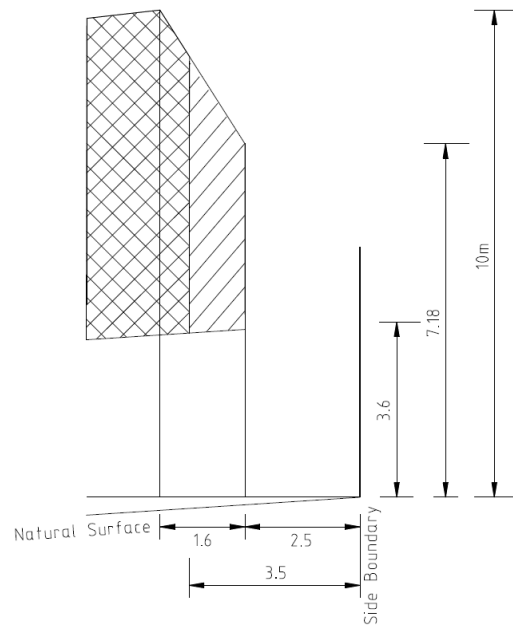

Natural Surface falling from side boundary.

Profile - SOUTH Boundary

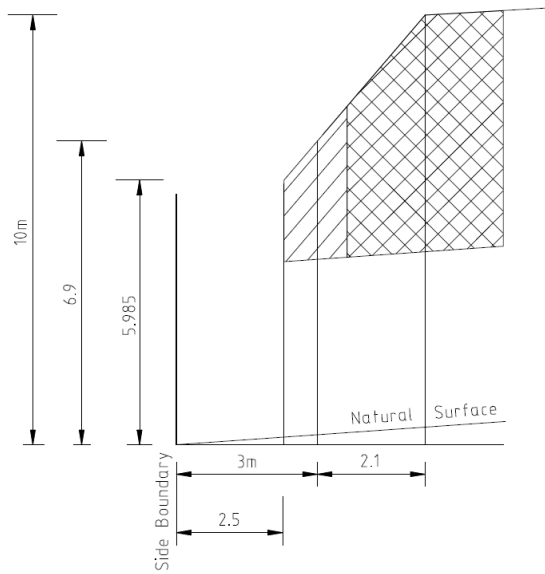

Natural Surface rising from side boundary.

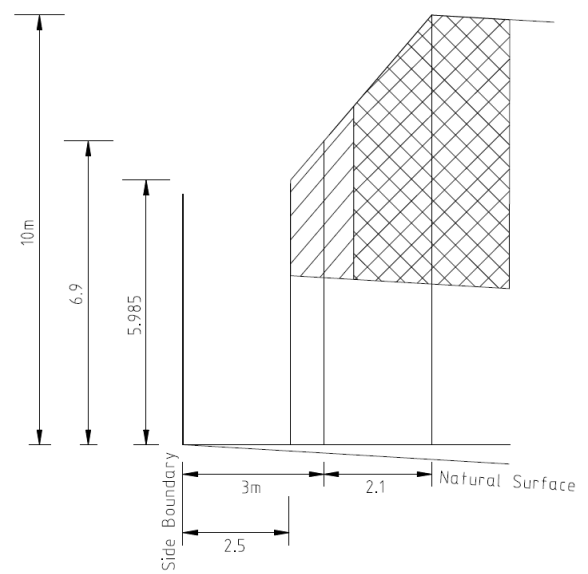

Natural Surface falling from side boundary.

(K) Profile - NORTH, EAST or WEST Boundary

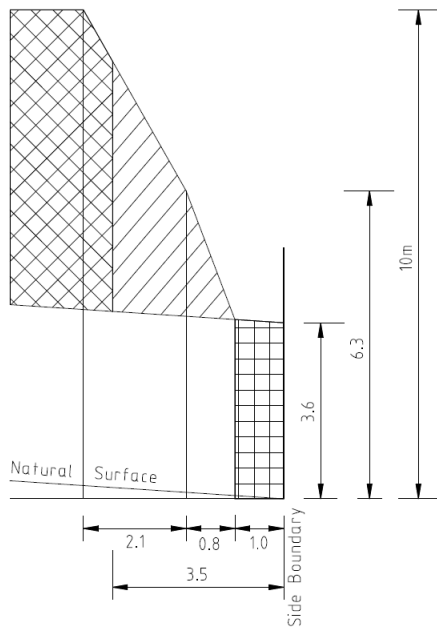

Natural Surface rising from side boundary.

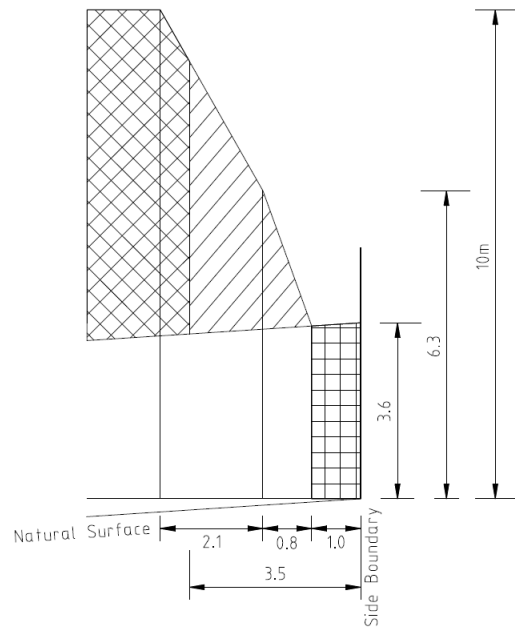

Natural Surface falling from side boundary.

(L) Profile - SOUTH Boundary

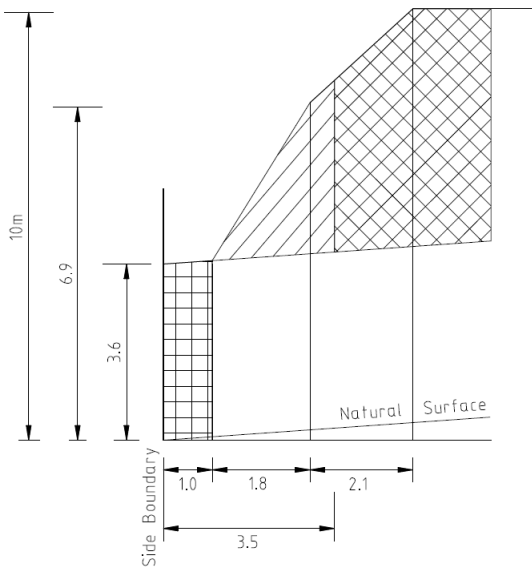

Natural Surface rising from side boundary.

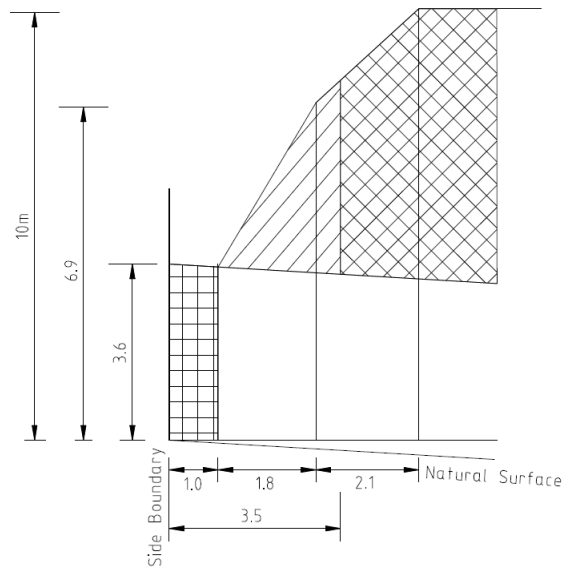

Natural Surface falling from side boundary.

(R) Profile - SIDE BOUNDARY

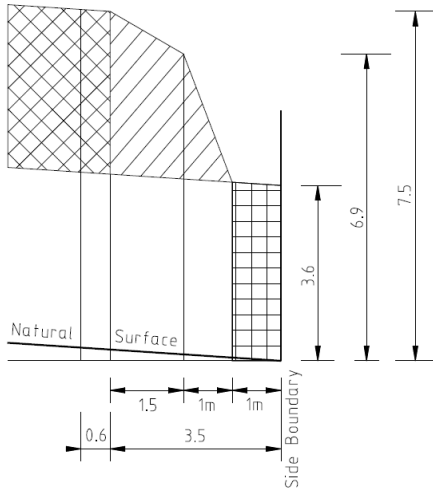

Natural Surface rising from side boundary.

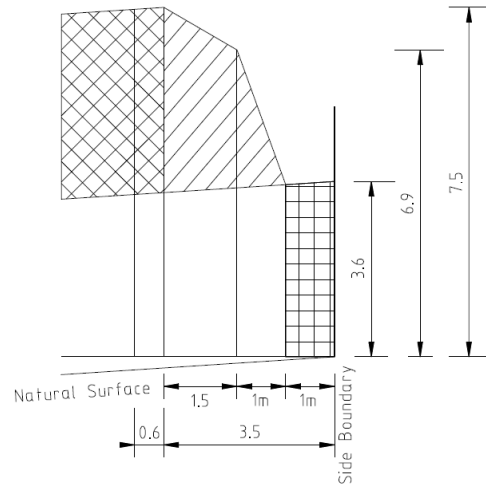

Natural Surface falling from side boundary.

(S) Profile - SIDE BOUNDARY

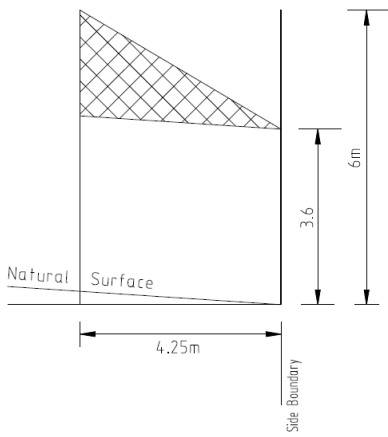

Natural Surface rising from side boundary.

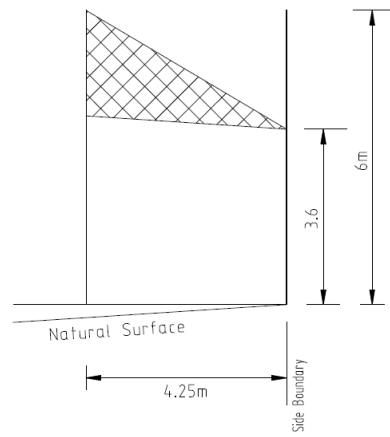

Natural Surface falling from side boundary.

Ⓣ Profile - SIDE BOUNDARY

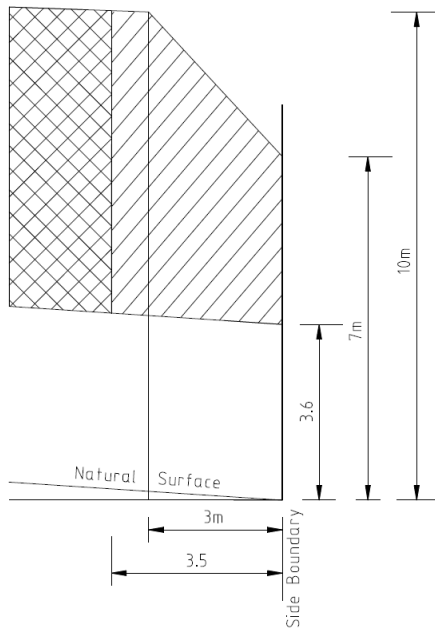

Natural Surface rising from side boundary.

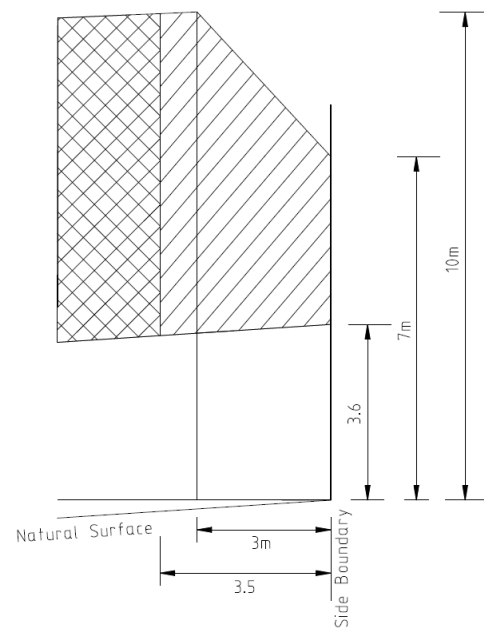

Natural Surface falling from side boundary.

Ⓥ Profile - NORTH, SOUTH, EAST or WEST Boundary

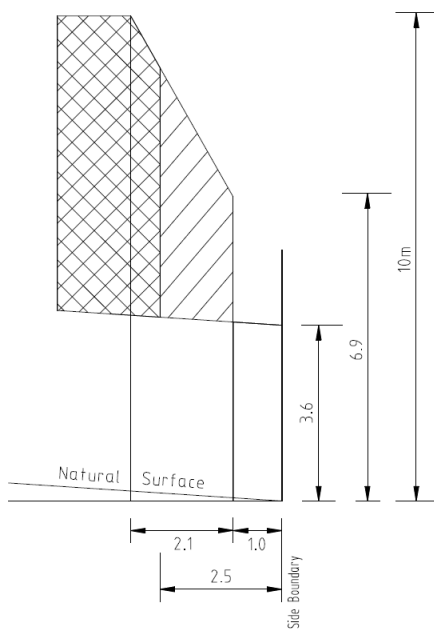

Natural Surface rising from side boundary.

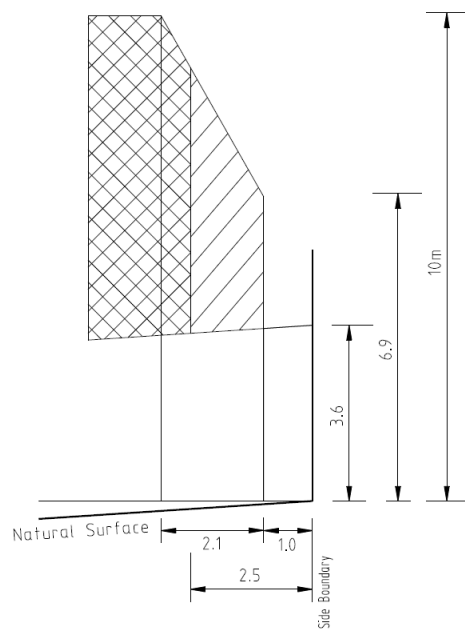

Natural Surface falling from side boundary.

9. CHECK LIST

PLEASE COMPLETE THIS CHECK LIST AND SUBMIT TO THE DAP WITH YOUR PLANS FOR APPROVAL TO:

MARRIOTT WATERS DESIGN ASSESSMENT PANEL
P.O. Box 356
Mont Albert, Vic. 3127

LOT NO:	
NAME:	
POSTAL ADDRESS:	
TELEPHONE (BH):	
DESIGNER/ARCHITECT:	
BUILDER:	

<u>For DAP Use Only</u>	
Date Submission Received:	
Re-Submission Required:	
Areas of Non-Compliance:	
Date Approval Granted:	

This Checklist will assist in determining whether your house design complies with the MARRIOTT WATERS Design Guidelines.

If your plans comply, you can expect your plans to be approved by the DAP within ten working days.

IS THE FOLLOWING INFORMATION INCLUDED IN YOUR APPLICATION?

	YES	NO
House floor plans at a scale of 1:100 (two copies)		
Elevations from four sides at a scale of 1:100 (two copies)		
Roof plan (two copies)		
Site plan at scale of 1:200 showing (two copies) <ul style="list-style-type: none"> - Setbacks from all boundaries - Building Envelope - Existing contours - Proposed finished floor levels and site levels - External features including driveways, paths, fencing and outbuildings - Landscaping 		
Schedule of external materials and colours		
Energy First Rate report		

DOES YOUR HOUSE DESIGN COMPLY WITH THE GUIDELINES?

	YES	NO
CONSTRUCTION OF YOUR HOME:		
On what date did you settle your lot? -----		
Will you commence construction within 18 months of settlement?		
SITING & ORIENTATION:		
Do you propose to build only one dwelling on the allotment?		
Does your house face the main street?		
Is your home and associated buildings, including the garage, contained within the Building Envelope (if applicable)?		
Are there any encroachments into the specified setbacks?		
Are they allowable encroachments?		
What profile types apply to your allotment (Refer Building Envelope Plan) - Profile Types		
Is your home and associated buildings designed within the profile?		

	YES	NO
Has your home been sited with living areas facing north to take advantage of solar orientation?		
Is the height related setback from the side boundaries achieved?		
Does your design meet the site coverage requirement of less than 60% of the lot (for S and T profiles 70%)?		
BUILT FORM:		
ROOF		
Material _____		
Colour _____		
WALLS		
Material _____		
Colour _____		
TRIM		
Material _____		
Colour _____		
Is your allotment size equal to or greater than 500sqm? If so, does your home exceed the minimum size required of 160sqm (approx. 17 squares) excluding garage?		
Is your allotment size less than 500sqm? If so, does your home exceed the minimum size required of 130 square metres (approx. 14 squares) excluding garage?		
Is your allotment a "terrace" allotment? If so, does your home exceed the minimum size required of 85 square metres (approximately 9 squares) excluding garage? Is your garage set back at least 5.5 metres from the street frontage?		
Does your home achieve an energy rating to the minimum standard required by the current Building Regulations? If so, what star rating does your home achieve? stars		
Are you planning on installing a Split System Air Conditioner? Does your planned system have a heating and cooling star rating that meets or exceeds 5 stars?		
Are you proposing a second garage? If so, is only one double garage door visible from the main frontage of the house?		
Is your house two-storey? If so, is the upper level stepped back?		
Does your house overlook/overshadow your neighbour's private open space areas?		
Does your house allow you to look into your neighbour's habitable rooms?		
EXTERNAL CONSIDERATIONS:		
Does your design allow for only one driveway?		

Do you accord with the No Front Fence restriction?		
Is there fencing between the front lot boundary and the building line?		
	YES	NO
Does your side and rear fencing comply with the fencing guideline?		
Does your design include a 32mm lead-in conduit for connection to the optical fibre network?		
Have you made provision for wiring your home for broadband, telephone and TV?		
Does your design include additional plumbing to provide for recycled water to the toilet, irrigation and other external uses?		
Have you placed external fixtures such as clothes-line, solar water heaters etc in positions that are not visible from the street?		
Have you made provision for locating your antenna within the roof of the house?		
If you are proposing an air-conditioner, is it located below the eaves line at the rear of the house?		
If you are proposing an evaporative air cooler, can it be seen from the front of the street? What colour is it? _____		
Does the house have internal plumbing?		
Will the landscaping of your front garden be complete within three months of you occupying your house?		

HOW ENERGY EFFICIENT IS YOUR HOME?

Energy efficiency and sustainability is encouraged. This section is not required to be completed in order to obtain DAP approval however this information will assist in assessing the ongoing sustainability of the PASADENA community.	YES	NO
Have you visited Villawood's <i>Positive Change</i> website? www.villawoodpositivechange.com.au		
Have you completed the 'My Wishlist' section? If so, what is your carbon reduction? (CO ₂ -e/1 st yr) what is your water usage reduction? (H ₂ O /1 st yr)		
Will you be installing any of the following:		
• Double glazed windows?		
• Solar Hot Water service?		
• Additional insulation?		
• Eaves?		
• External shutters or blinds shading east or west?		
• Energy efficient light globes?		
Will you endeavor to install energy efficient appliances?		
Do you plan to connect to 'green energy'?		
Will you install solar panels to provide electricity?		
Is gas heating your preferred method of heating your house?		

Are you proposing to install air conditioning? If so, what type is proposed? (please tick)		
<input type="checkbox"/> Evaporative		
<input type="checkbox"/> Reverse Cycle		
What type of heating are you installing? (please tick)		
Ducted Gas <input type="checkbox"/>	Slab <input type="checkbox"/>	Hydronic <input type="checkbox"/>
Electric <input type="checkbox"/>	Other.....	